

# 令和元年度 新人大会東部地区本戦 (男子シングルス)

1R 2R 3R 4R 5R 6R Final 6R 5R 4R 3R 2R 1R

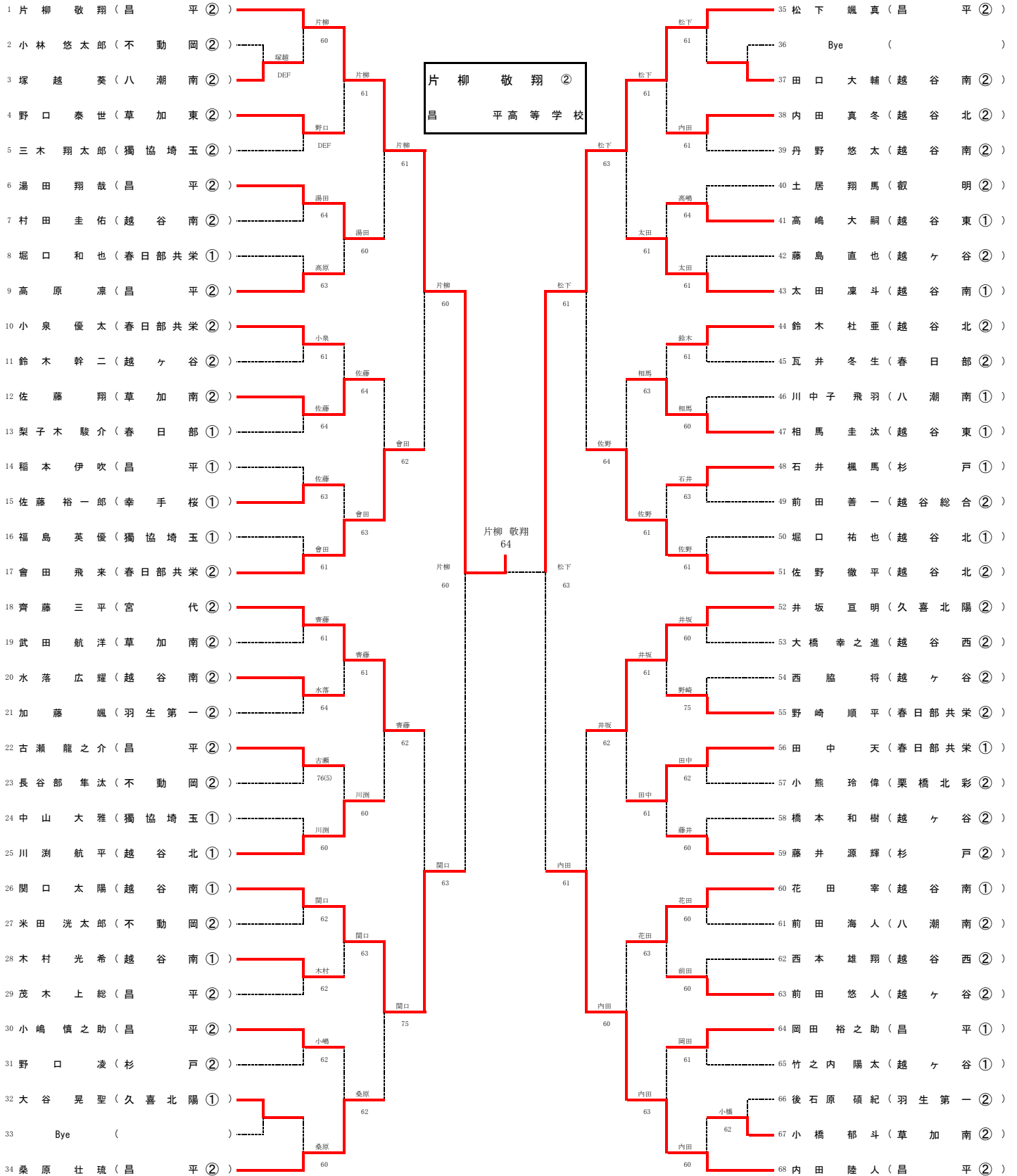

3・4位決定戦

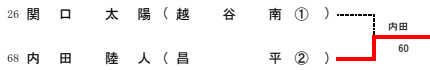

5・6位決定戦



7・8位決定戦

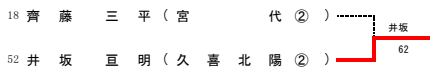

9・10位決定戦

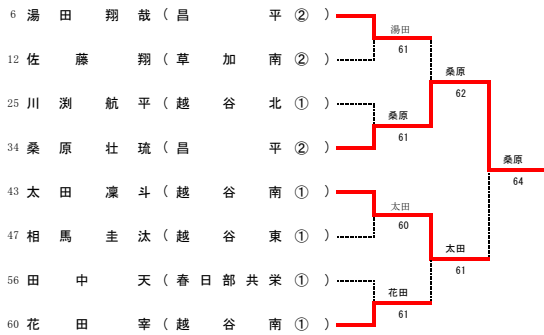

11・12位決定戦

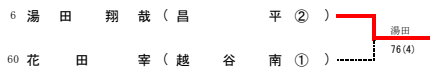

13・14位決定戦



15・16位決定戦

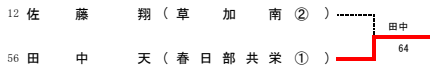

17・18位決定戦

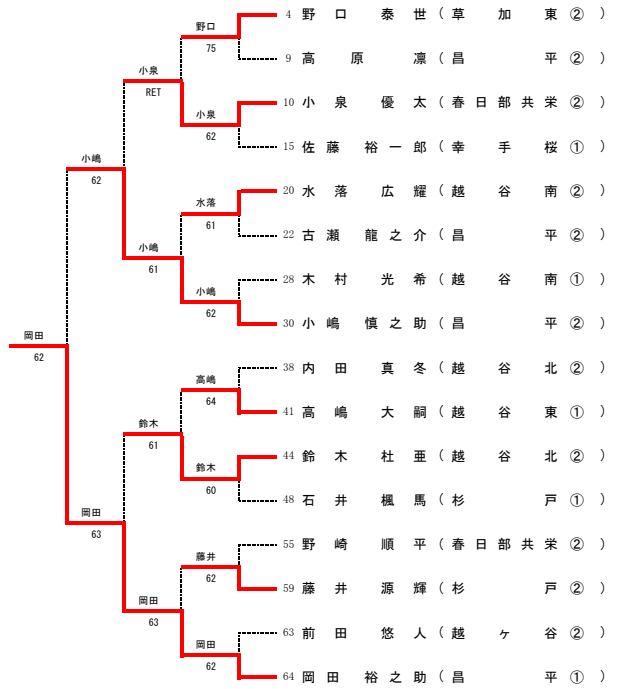

19・20位決定戦

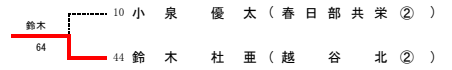

21・22位決定戦



23・24位決定戦

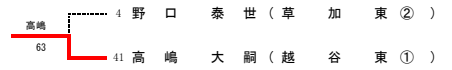

25・26位決定戦

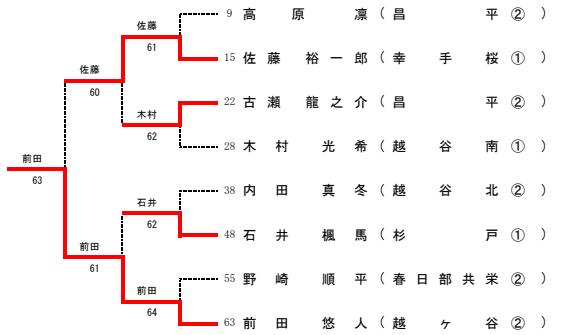

27・28位決定戦

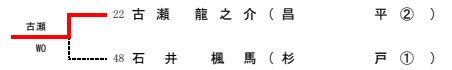

29・30位決定戦

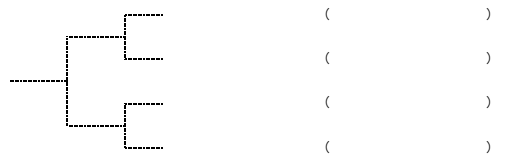

31・32位決定戦

