

令和5年度 新人大会東部地区予選 (男子シングルス)

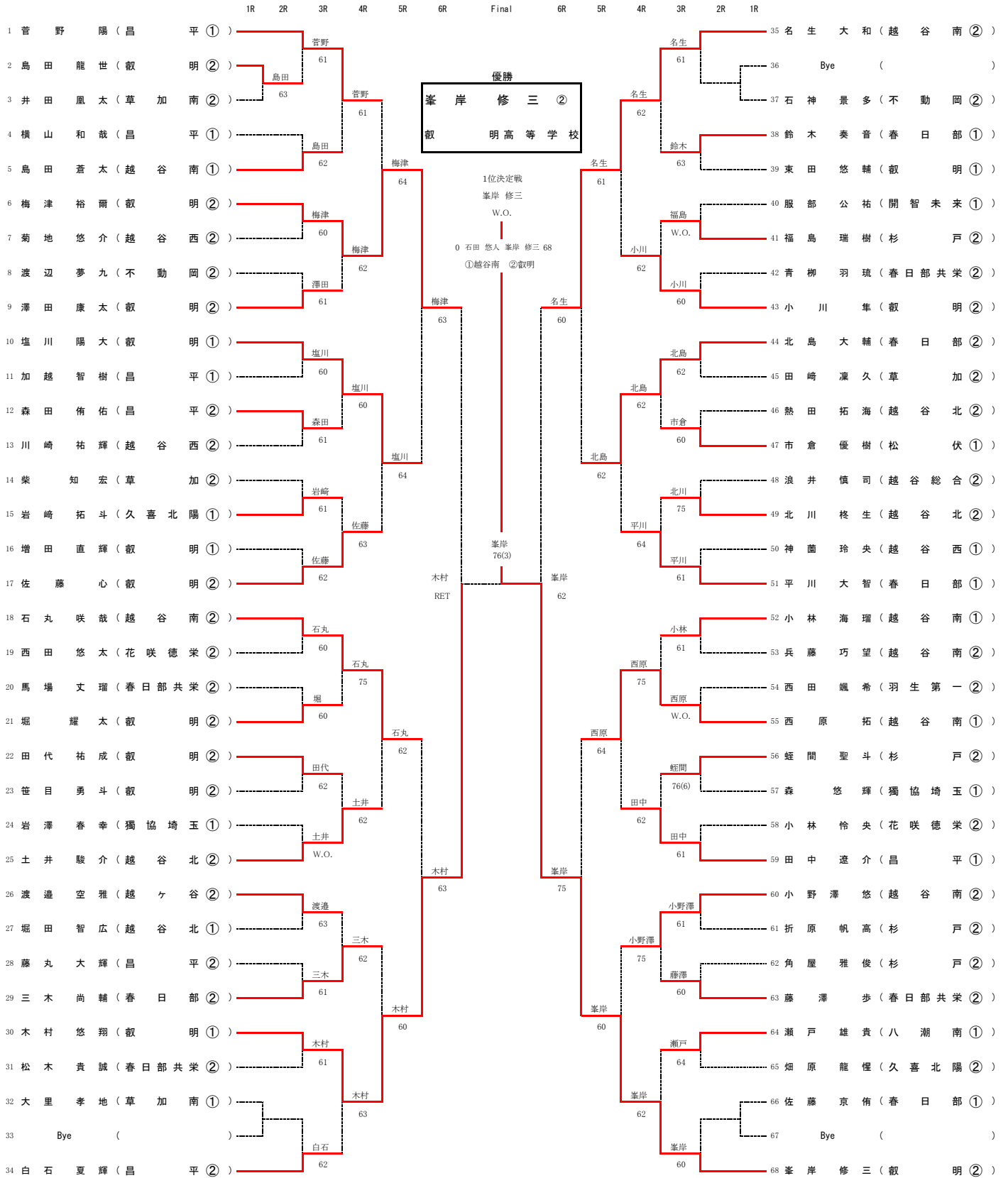

3・4位決定戦

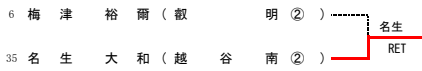

5・6位決定戦



7・8位決定戦

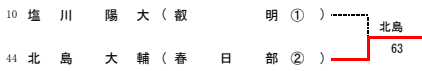

9・10位決定戦

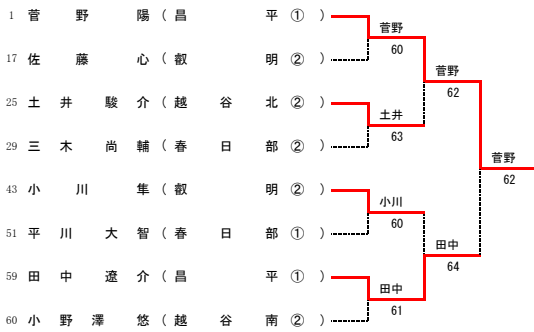

11・12位決定戦

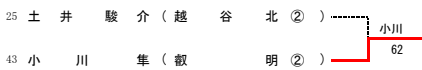

13・14位決定戦



15・16位決定戦



17・18位決定戦

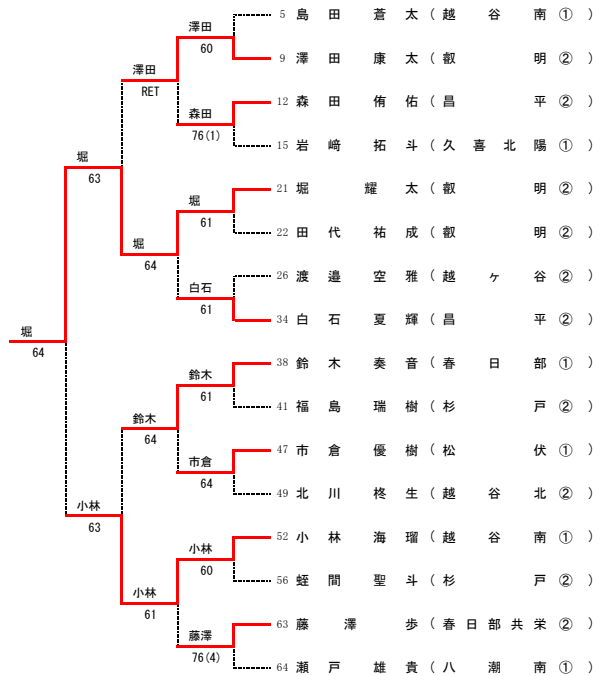

19・20位決定戦

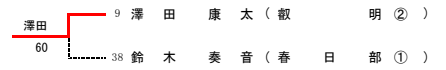

21・22位決定戦

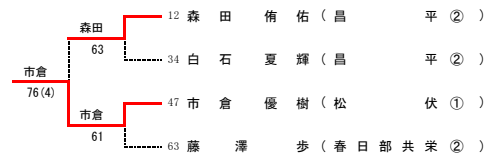

23・24位決定戦

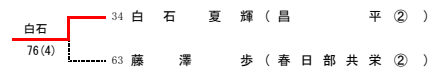

25・26位決定戦

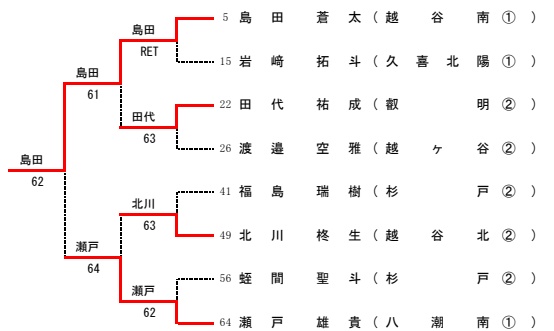

27・28位決定戦

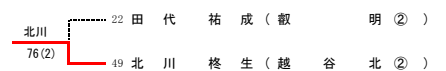

29・30位決定戦

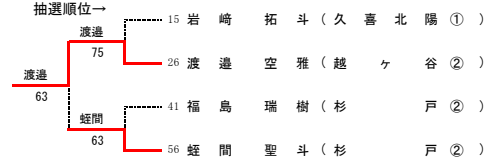

31・32位決定戦

